

Assembly and instruction manual for the Ripple Tank no. 2211.00

20.01.12

Ae 2211.00

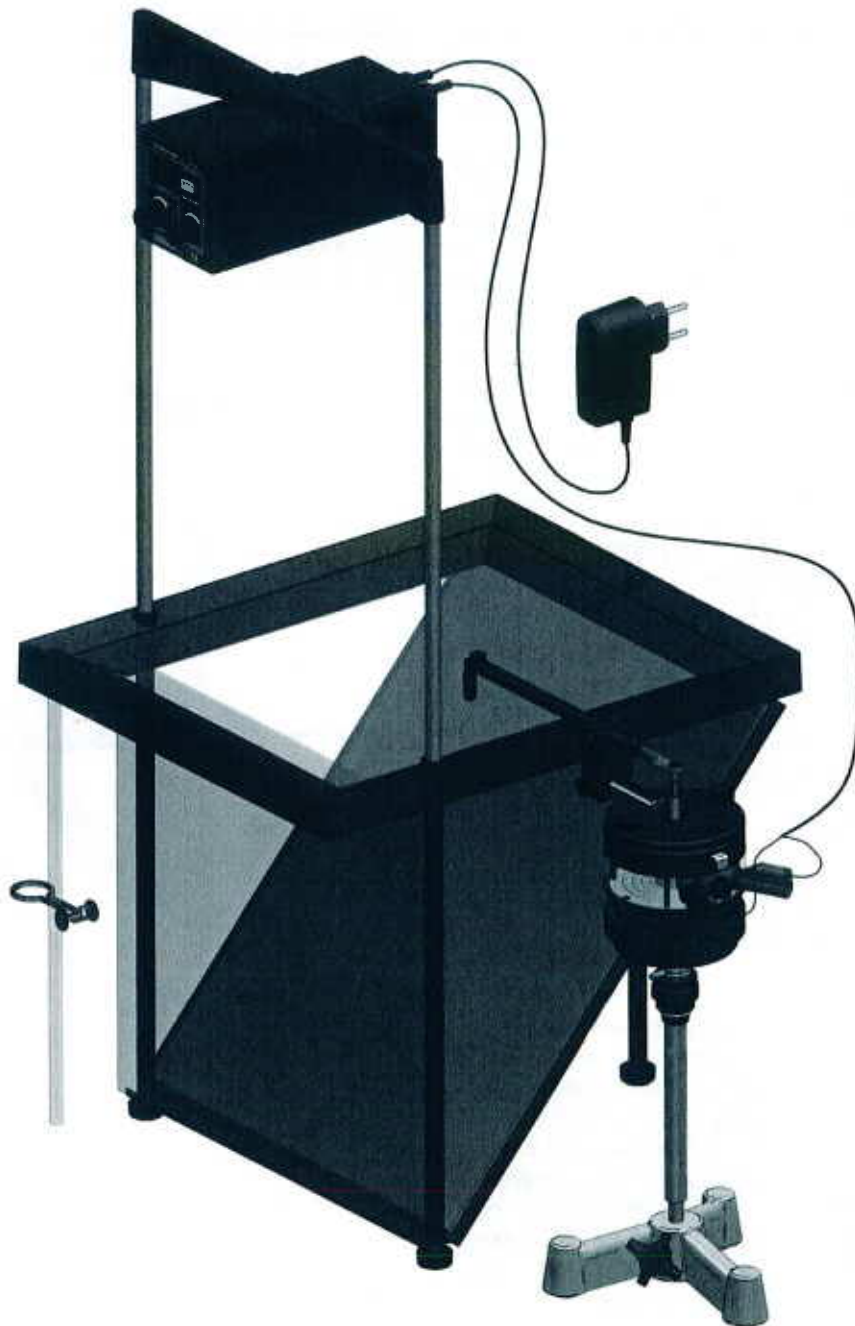

A/S Søren Frederiksen, Ølgod
Viaduktvej 35 · DK-6870 Ølgod

Tel. +45 7524 4966
Fax +45 7524 6282

info@frederiksen.eu
www.frederiksen.eu

Frederiksen

The Ripple Tank comprises the following individual parts:

- Ripple Tank (2210.33) 1 pcs.
- Detachable legs (2210,1013) 3 pcs.
- Plate fitting (2210,1013) 1 pcs.
- Frosted glass plate (2210,5093) 1 pcs.
- Mirror (2210,1011) 1 pcs.
- Silicone tube (0385.30) 1 pcs.
- Clamp (0395.10) 1 pcs.

- Fixing rods for Strobe-unit (2210.62) 2 pcs.
- Traverse f. Strobe-unit (2210.62) 1 pcs.
- Strobe-unit 2211.01) 1 pcs.
- Power Supply (3550.50) 1 pcs.

- Vibration Generator (2185.00) 1 pcs.
- Mounting pin 2185.06) 1 pcs.
- Holder for lever arm (2185.05) 1 pcs.
- Lever Arm w. pivot (2210.32) 1 pcs.
- Height adjust unit (2185.07) 1 pcs.

- Acrylic block, concave (210.28) 1 pcs.
- Acrylic block, convex (2210.29) 1 pcs.
- Acrylic block, rectangular pcs. (2210.30) . . . 1 pcs.
- Single dipper (2210.22) 1 pcs.
- Double dipper (2210.23) 1 pcs.

- Dipper for parallel waves w. plane wave attachment (2210.25) 1 pcs.
- Single dipper (unmounted) (2210,2202) 5 pcs.
- Acrylic barrier, long (2210.26) 2 pcs.
- Acrylic barrier, short (2210.27) 1 pcs.
- Pipette flask w. special solvent (2210.31) . . . 1 pcs.

- Connection cable for Vibration Generator (1100.75) . 1 pcs.
- Remote Control (1100.80) 1 pcs.
- Storage box, partitioned 1 pcs.
- Assembly and instruction manual 1 pcs.

Numbers in brackets are for ordering spareparts.

The holder for the Vibration Generator may be replaced by a lab jack e.g. no. 0036.00. A plastic washer bottle e.g. 500 ml may move useful.

Ripple Tank:

Dimensions: 314 x 363 x 30 mm. The rectangular Ripple Tank comprise a square frame with a bottom made of 3 mm glass. The tank has 3 external fixtures with internal threading for mounting the detachable legs, further 2 of them also serve as fixtures for the rods used in conjunction with the traverse to fix the Strobe-unit in position. "Artificial banks" made of plastic foam are mounted along the internal sides of the tank for the purpose of eliminating waves reflected off the side of the tank.

Detachable legs:

The 3 pcs. detachable legs should be mounted in the threaded fixtures of the tank. The detachable legs all have levelling feet.

Frosted glass plate:

Dimension: 300 x 330 x 3 mm. A translucent screen made of a special type of acrylic extremely well suited for projection purposes.

Fixing rods for Strobe Unit:

Made of Ø 10 mm stainless steel threaded in one end to fit into the two foremost fixtures of the ripple tank - when viewed from the top.

Traverse for Strobe-unit.

Traverse with a milled indentation for attaching the Strobe-unit , with a hole in each end for the fixing rods. The traverse simply plugs onto the fixing rods.

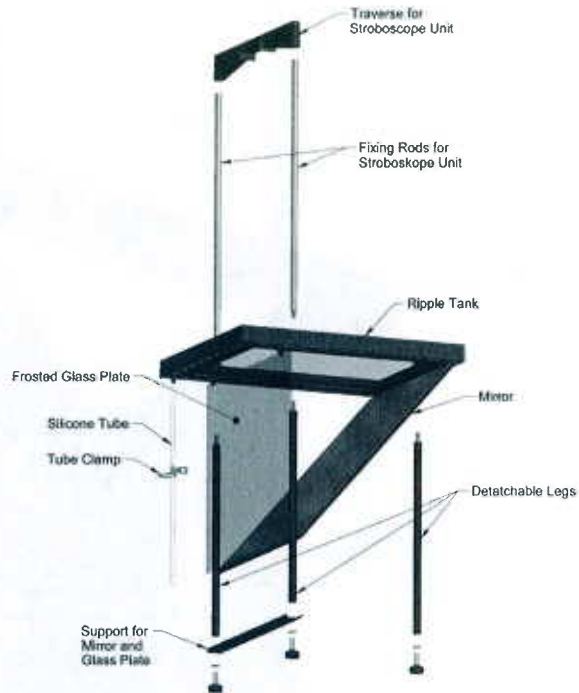

The Strobe-unit no. 2210.60

The unit comprises the following main parts:

The lights source is a white LED (3W). The LED has a very long lifespan, estimated up to 100.000 hours, thus a change of light source will not be relevant.

Display of frequency

The Strobe-unit is equipped with a digital display allowing you to monitor the frequency of the pulses applied to the vibration generator.

Remote Control

If the button »Reg. Frequency« is turned fully counterclockwise, the LED will be on continuously. The remote control may then be used to control the vibration generator thus that each time it is activated means propagation of one singular wave. A good idea when in the initial stages of the study of wave propagation. Further apply a drop of the special solvent and activate the remote control once more to demonstrate that waves may pass through each other without any visible result.

The Vibration Generator and the dippers

The Vibration Generator converts the pulses from the Strobe-unit to rising and falling signals. In principle exactly alike the function of an ordinary loud-speaker. The rising and falling signals are via the lever arm and pivot transferred to the various dippers supplied resulting in different movements yielding different types of waves. Horizontal adjustment of the dippers may be done by loosening the screw fixing the lever arm pivot to the horizontal holder. Vertical adjustment by means of the adjustable holder for the vibration generator or the lab jack (both are optional extras).

Mounting the lever arm: N.B. Whenever mounting accessories to the vibration generator's movable centre pin you should always make sure that it is locked. If it fails to go into "Lock" position carefully move the centre pin up and down until the lock catches on. Mount the horizontal holder on top of the vibration generator thus that the mounting pin points in opposite direction of the input terminals. Fix the horizontal holder to the vibration generator by means of the 2 thumb screws supplied. Then mount the lever arm and pivot on the mounting pin and push the lever arms banana plug into the centre

Front view of stroboscope unit



pin until the lever arm is parallel to the top of the vibration generator. Make your choice of dipper and mount it on the lever arms free end and fix the lever arms pivot to the mounting pin by tightening the thumb screw. The locking mechanism may now be set in "Unlock" position.

The vibration generator may now be placed on a lab jack or on the adjustable holder on base. It is very

important that height adjustment of the vibration generator can be done quite easily.

Connect the vibration generator to the strobe-unit by means of the connection cable included. The vibration generator is protected against overload by means of a fuse. In case of overload replace the fuse located between the terminals by a similarly rated fuse only!

Rear view of stroboscope unit

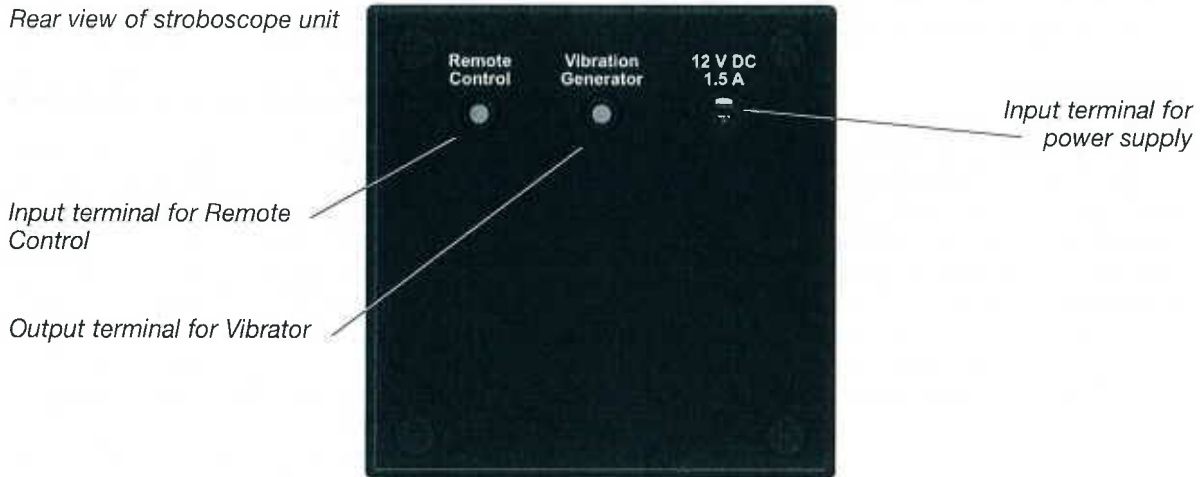



Single Dipper.



Double Dipper.



Dipper for Parallel waves.



Single Dippers (unmounted)



Barriere.



Acrylic block, concave.



Acrylic block, connex.



Acrylic block, rectangular.



Pipette.

Dippers:

The single dipper:

Utilised for experimental demonstration of the wave formula and the Doppler effect. The wavelength may be measured by marking the distance between e.g. 10 waves on the projection screen, then measure the same distance immediately over the water surface by means of a caliper gauge as you observe the projection of the caliper gauge on the projection screen. Regulate the frequency and record the frequency in position "Synchron". The measurements can be made at different frequencies.

Demonstrate the Doppler effect by moving the vibration generator in a unison movement in parallel along the side of the ripple tank, while you observe how the wavelength decreases in the area in front of direction of movement and respectively increases in the area behind the direction of movement. A simple trick that may be of help is to place a sheet of paper under the vibration generator in order to overcome the friction between the vibration generator and the surface it is located on.

The double dipper:

A good tool to demonstrate interference patterns. The distance between the 2 dippers can be adjusted simply by sliding the dippers along the holder.

The plane wave dipper:

This dipper may be used for the demonstration of reflection and refraction. Remove the plane wave attachment to alter this dipper to a parallel wave dipper with 19 points. The single dippers (mounted or unmounted) supplied can be mounted on this device thus changing it to a wave propagation app. with 7 dippers in line.

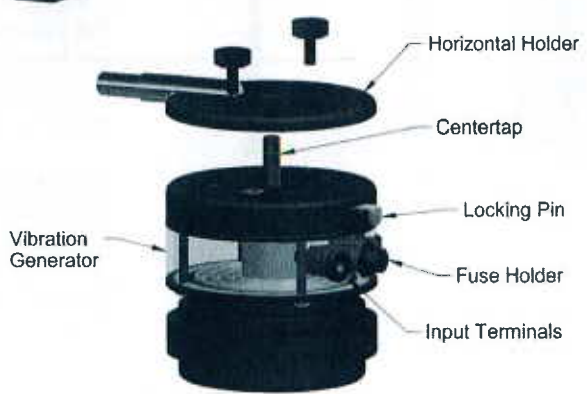

The barriers:

The kit comprises 2 long and 1 short barrier which allows you to form a single or a double slit for diffraction experiments.

The acrylic blocks:

The acrylic block is a set of 3 transparent blocks utilised to demonstrate that the velocity of propagation will vary with different depths. Place the block in the tank thus that the depth is quite shallow over the block but deeper elsewhere in the tank. By letting plane parallel waves pass over different shapes of acrylic blocks it is possible to demonstrate how the shape of the blocks influence the refraction of the waves. By lowering the water depth the very same blocks can be used to demonstrate reflection.

**A pipette:**

A pipette filled up with water may be used to demonstrate how water drops falling can propagate singular waves.

Assembly of the ripple tank:

Attach the 3 detachable leg to the ripple tank. The 2 angular holders must be inserted in between the fixtures and the 2 front legs. Likewise the plate holder is inserted between the leg and the levelling feet of the 2 front legs. The plate holders oblique edge must point backwards - in direction towards the third leg. Mount the fixing rods for the strobe-unit in the upward threading of the same fixtures as the 2 front legs are attached to. Then attach the strobe-unit to the traverse in the milled indentation. The strobe-unit is fixed in position by means of a thumb screw. The traverse simply plugs onto the 2 fixing rods. The strobe-unit should be placed with the display facing you when viewed from the front. The frosted glass plate and the mirror slides in place under the tank, the mirror in an oblique position.

Adjust the tank to level by means of the levelling feet. If the table top is level it may be sufficient to adjust the hind leg, as this leg is slightly shorter than the 2 front legs with the angular holders inserted. A spirit level could come in handy for this job.

Mount the horizontal holder and lever arm with pivot on the vibration generator and locate it on e.g. a lab jack or the holder for the vibration generator (not included). Connect the vibration generator to the strobe-unit by means of the connection cable included.

Connect the strobe-unit to the included power supply.

Filling in water:

Distilled or demineralised water is recommendable in order to avoid problems related to deposits of chalk. Filling in water and later regulations of the volume of water is best done by means of a 500 ml plastic washer bottle. Approx. 500 ml of water would be suitable i.e. a water depth of approx. 6-7 mm. Problems in relation to surface tension is avoided by adding 2-3 drops of the special solvent supplied in the pipette flask. Disperse the solvent along the foam liners on the tank with the finger tip. Likewise it is advisable to apply just a little of this solvent to the dippers before taking them into service.

Adjustment of the projected patterns, the dippers and the signal applied:

Lower the dipper(s) into the water e.g. by means of a lab jack. Set the strobe-unit to a frequency of approx. 30 Hz. Adjust the applied signal by means of

the strobe-units button "Reg. Amplifier" and the vertical position of the dipper(s) until the projected patterns are the best and clearest possible. The best method is to lower the dipper quite deep into the water and then adjust it upwards until the best possible patterns are achieved. Too high frequencies will obstruct formation of wave patters over the entire surface. The use of broad dippers e.g. dippers for plane waves may necessitate a further adjustment of

the dipper as it must be as parallel to the surface as possible. Simply loosen the screw attaching the lever arms pivot to the horizontal holder and rotate it to a parallel position.

Projections.

The need to black out the lab is to a certain extent dependant of the circumstances and the type of experiments.

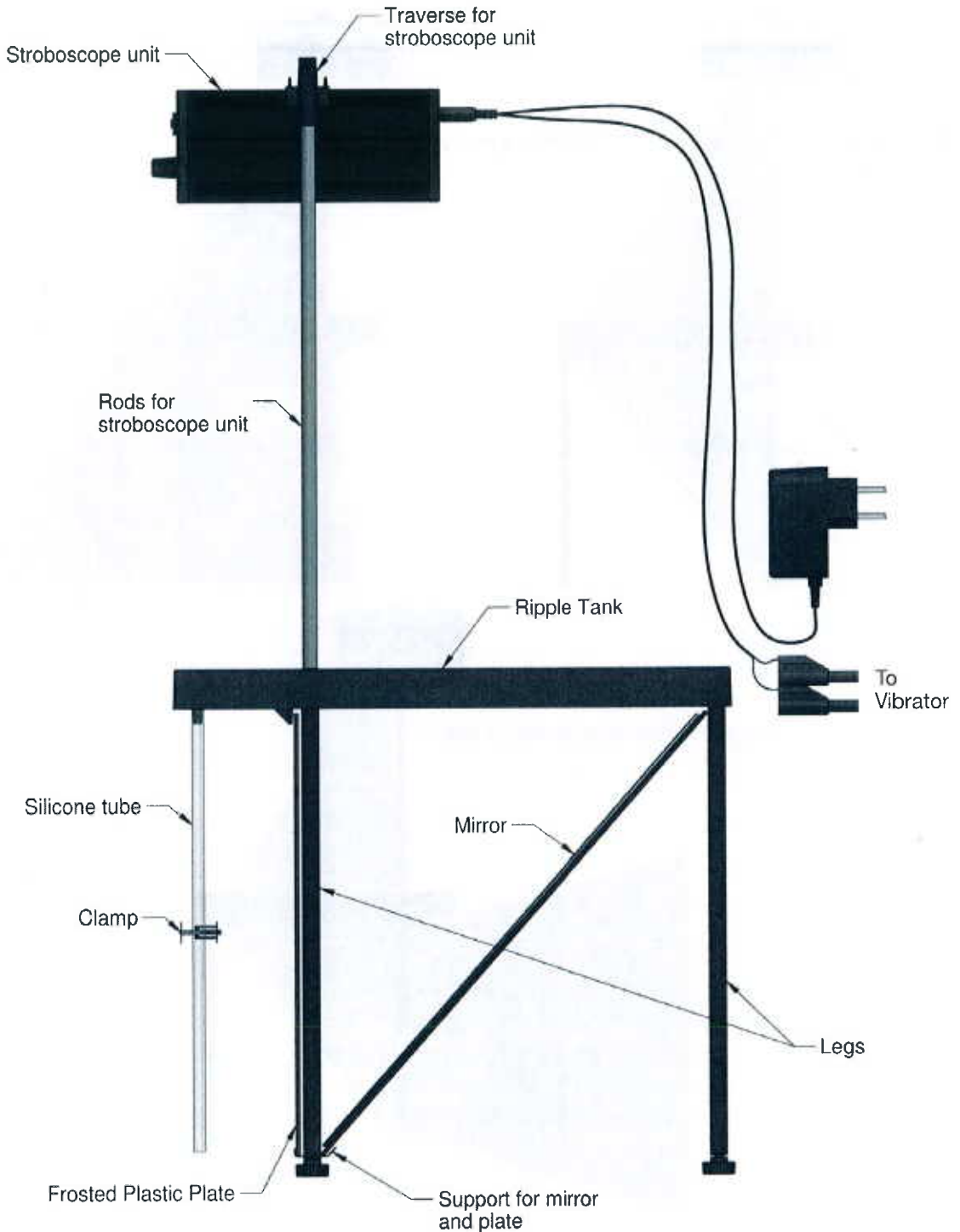

The propagated waves and patterns may be projected onto various surfaces. So far an oblique mirror has been used to project the patterns onto a frosted glass plate perpendicular to the ripple tank. This type of projection is well suited for demonstration and for group projects.

If however the frosted glass plate is removed projection onto larger screens will be a possibility whether it be a projection screen or just a white-washed wall in front of the ripple tank. The ripple tank should be placed quite high for this type of projections.

Projection on the table top is also possible if both the frosted glass plate and the mirror is removed. Placing a sheet of paper or white card board on the table top is quite expedient for this type of projections. This type of projection is extremely well suited for group projects as the propagated waves are projected onto quite a large field of vision. The student can place themselves around the screen as they please, and last but not least they can mark their observations directly on the screen!

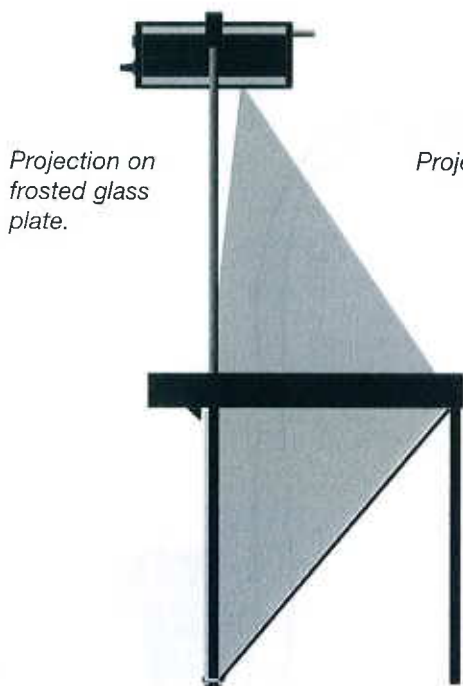

Projection on frosted glass plate.

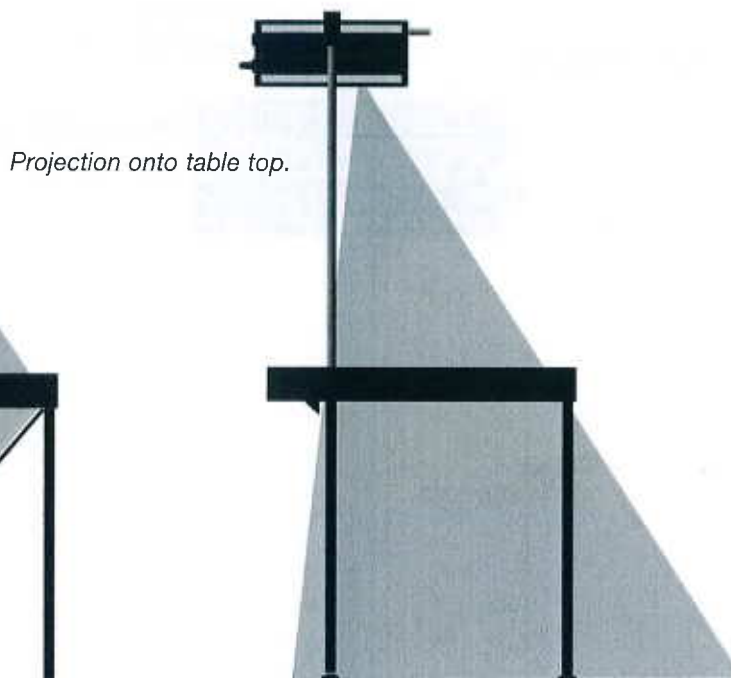

Projection onto table top.

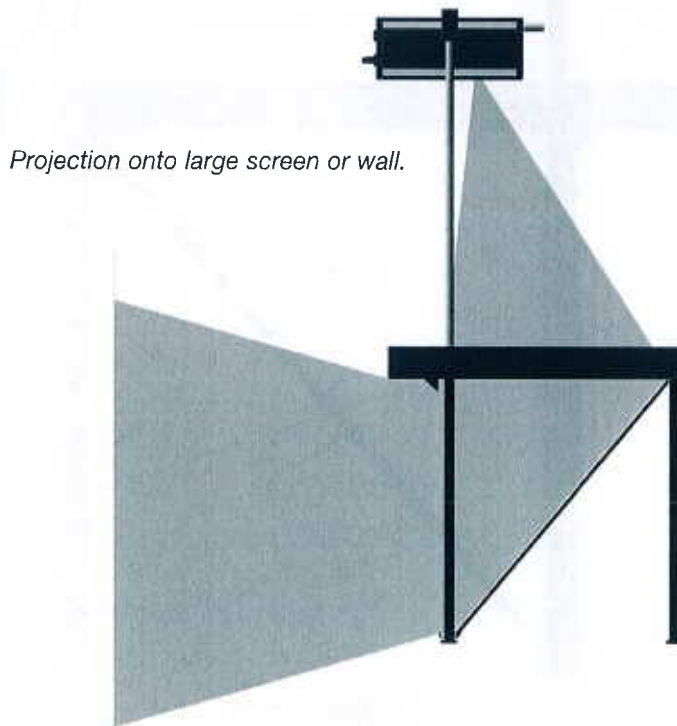

Projection onto large screen or wall.

WAVE TABLE EXPERIMENTS

Experimental series 1 speed of propagation

The purpose of this experiment is to demonstrate the relationship: $v = f \cdot \lambda$ where v is the propagation speed of the wave, f is the frequency and λ is the wavelength.

The water table should be assembled and placed on a white tabletop. The wave generator should be mounted with a plane wave generator (a plane wave dipper) which generates plane, parallel waves.

A row of light and dark stripes will be observed on the table top due to wave peaks and troughs respectively. One wavelength λ is the distance between two light or between two dark stripes. It may be necessary to regulate the amplitude of the wave generator to obtain reasonably sharp images of the waves on the table. Also, be sure that there are no bubbles or other impurities in the water container or on the wave generator.

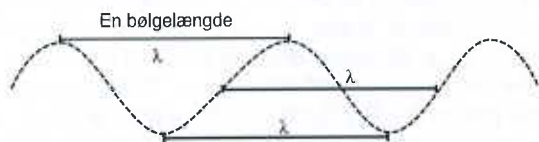

Figure 1: A harmonic wave.



The projection of the water waves on the table should look like this (λ is exactly one wavelength).

Exercise 1:

Using the ruler on the table measure the wavelength in meters, and make a note of the corresponding frequency read from the strobe light. Choose another frequency and repeat the measurements of λ and f . Make five sets of measurements in all.

Data table:

- a) Compute the speed $v = f \cdot \lambda$ for each pair of measurements, and write the result in the last row of the table.

f / Hz					
λ / m					
$v = f \cdot \lambda / (\text{m/s})$					

- b) Is the speed reasonably constant?
c) Compute the average value of v .

Exercise 2:

The equation $v = f \cdot \lambda$ can be rewritten as $\lambda = v \cdot f^{-1}$. Thus in a coordinate system with λ plotted as a function of f^{-1} a straight line should result with the speed v as the slope.

f^{-1} / s					
λ / m					

Draw a graph plotting in your data. Is the resulting graph a straight line through the origin (0,0)?

Find the slope of the line, and compare it with the average value of v which you found in Exercise 1.

Exercise 3:

Because it is difficult to measure λ exactly it is a good idea to repeat the exercise but to measure 5λ instead of λ . Do this for at least five sets of data.

Table for measurements and computations:

f / Hz					
$5\lambda / \text{m}$					
λ / m					
$v = f \cdot \lambda / (\text{m/s})$					
f^{-1} / s					

- a) Compute λ and v for each set. Is v roughly constant?
b) Compute the average value of v .
c) Draw a graph as in Exercise 2 but with λ plotted as a function of f^{-1} . Compute the slope v .
d) Compare the four values for v which you now have found: the average from Exercise 1, the slope from Exercise 2, and the average and the slope from Exercise 3.

Experimental series 2 varying the water depth

Exercise 1:

The wave generator is still the plane wave generator. A piece of glass with a thickness of about 2-3 mm is placed in the water container. (NB: It can be difficult to lift the glass plate up again, as it sticks to the bottom of the water container. This problem can be alleviated by putting a small piece of paper under one corner of the glass plate.) Regulate the water depth so that there is only a thin layer of water above the glass plate. Place a piece of paper on the viewing table and draw what you see.



Figure 2. Wave table with an extra glass plate added.

- Can you explain your observation? (The wavelength is reduced in shallow water, because the speed v is reduced.)
- Determine two values for λ one for deep water and one for shallow water. The best results are achieved when you measure e.g. five wavelengths as in Exercise 3 of Experimental Series 1. Compute the speed of the water wave using $v = f \cdot \lambda$.
- Try placing a thicker glass plate in the water. Regulate the depth so that there is just a thin layer of water above the plate. Draw and explain.

Exercise 2:

Set up an experiment as in Exercise 3, Experimental Series 1 but with a different water depth.

Experimental series 3 refraction and reflection

Exercise 1:

Prepare the following experimental setup:

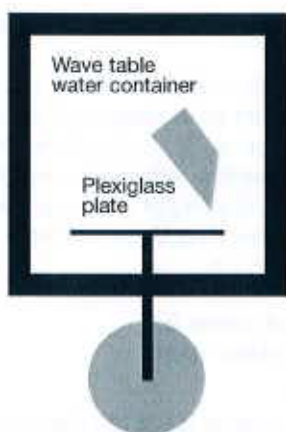

Figure 3: Setup for demonstrating the refraction of water waves.

Choose a frequency between 15 Hz and 30 Hz. Since the speed of propagation is lower in shallow water than in deep water, the wave will be refracted at the border between shallow and deep water. This means that the direction of propagation of the wave will change. The direction of propagation is always normal to the wave fronts.

Place a piece of paper on the table and trace the following: the border between deep and shallow water (i.e. the edge of the plexiglas plate) and 3 to 5 wavefronts both for deep and for shallow water:

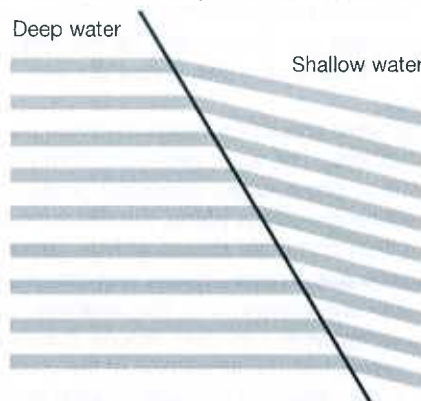

Figure 4. Refraction of water waves.

Data analysis:

Use your drawing to determine the wavelength both for the "shallow" water λ_{shallow} and for the "deep" water λ_{deep} . Measure also the angle of incidence i of the water waves and the angle of refraction b using a protractor. Remember that i and b can be measured as the angle between the wavefronts and the interface border.

$$\frac{\sin i}{\sin b} = \frac{\lambda_{\text{shallow}}}{\lambda_{\text{deep}}}$$

According to the law of refraction (Snell's law).

Exercise 2:

When waves strike a wall they will be reflected. In this case the law of reflection is valid. It can be expressed briefly as follows:

the angle of incidence equals the angle of reflection

It is quite difficult to observe the reflected wave in the water table, but using a frequency of about 40 Hz the reflection is reasonably clear. In this experiment it is important to adjust the amplitude until the reflection becomes clearly visible. The same setup should be used as in Exercise 1 (Figure 3), but the water level should be regulated so that the plexiglas plate is not covered with water. Put a piece of paper on the table under the water table and draw the wave fronts and the surface which reflects the waves. Measure the angle of incidence and the angle of reflection, and check to see if they are equal.

Experimental series 4

Wave Diffraction by corners and holes

Exercise 1:

Place a barrier in the water table as illustrated in Figure 4 (left). Check whether the water waves can "turn corners" using various wave generator frequencies. Repeat with another barrier. The water level should not cover the barrier.

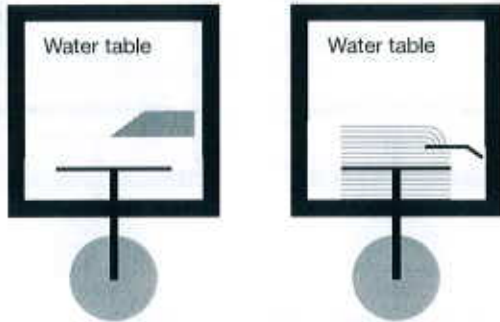

Figure 4: Water table with barriers.

Exercise 2:

Place the two barriers as shown in Figure 5. By changing the frequency the wavelength λ can be changed.

- What happens to the waves at the corner or the hole when the frequency f is increased?
- What do you observe happening to the waves?
- Can you get the waves with leave the hole to look like ring-shaped waves?



Figure 5: Plane waves striking a hole in a barrier.

Exercise 3:

Check what happens to the waves when they encounter a small barrier, e.g. a "pole" or similar object. Make a setup like the one shown in Figure 6.



Figure 6: Water waves encountering a small barrier.

Experimental series 5 wave interference

When two waves meet they will form an interference pattern. When the waves reinforce one another it is called constructive interference, and when the waves cancel one another out it is called destructive interference. This phenomenon can be examined by mounting a double dipper unit on the wave generator so that an interference pattern is created in the water table and on the observation surface below. When the two waves meet they will create a pattern as shown in Figure 7, where the thin lines indicate points of constructive interference.

The interference phenomenon can be described by the double slit equation:

$$\sin \theta_m = \frac{m \cdot \lambda}{d}$$

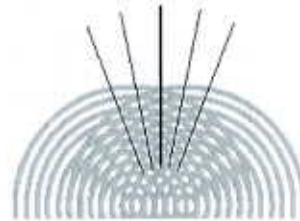

Figure 7: The interference pattern of 2 circular waves.

where m is the order of the interference line, θ_m is the angle between the 0th order line and the line of interest, d is the distance between the two dippers and λ is the wavelength of the water waves.

Because the water wavelength is difficult to measure in the interference pattern, this should be done indirectly. The speed of propagation of the water waves is determined using just a single dipper and with no barriers in the water.

The speed of propagation is found just as in Experimental Series 1. Since this speed is constant for a constant water depth, the wavelength to use can be found by using the equation:

$$v = f \cdot \lambda \Leftrightarrow \lambda = v/f$$

where the frequency can be read on the stroboscope.

Exercise 1:

Mount the wave generator with two dippers. Measure the distance d between them. When the interference pattern is clearly visible on the table below the water table (it may be necessary to adjust the amplitude), trace it on a piece of paper. There are some clear, light stripes – that is where there is destructive interference. The constructive interference occurs at the midpoint between the stripes. Mark also the positions of the two dippers. Connect the two points on the drawing. The interference stripe which is normal the line connecting the two dippers is the 0th order line. Read off the frequency f from the stroboscope, and measure the angles θ_m between the various interference lines and the 0th order line. Check whether the condition that $\sin \theta_m$ equals the value $m \cdot \lambda/d$ is fulfilled. Repeat for several frequencies. Use the table to collect the measured data and for calculations:

$v_{\text{wave}} = \text{m/s}$ $d = \text{m}$

	Exp. 1	Exp. 2	Exp. 3	Exp. 4	Exp. 5
f / Hz					
λ / m					
m					
$m \cdot \lambda/d$					
θ_m					
$\sin \theta_m$					

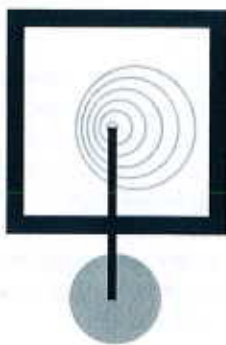

Figure 10: The Doppler effect.

Exercise 2:

This experiment can also be performed by sending plane waves towards a barrier with two apertures (i.e. openings) as shown in Figure 8. The only change compared with Exercise 1 is that now d is the distance between the two apertures in the barrier instead of the distance between the two dippers. The interference pattern will appear as shown in Figure 9.



Figure 8: The water table with a barrier with two apertures.



Figure 9: The interference pattern from a double slit.

The measurements from Exercise 1 can be repeated, and it can be demonstrated that the double-slit formula is also valid for a barrier with two apertures.

$v_{\text{wave}} = \text{m/s}$ $d = \text{m}$

	Exp. 1	Exp. 2	Exp. 3	Exp. 4	Exp. 5
f / Hz					
λ / m					
m					
$m \cdot \lambda/d$					
θ_m					
$\sin \theta_m$					

Experimental series 6, the doppler effect

The Doppler effect can be demonstrated using the water table. Mount the wave generator with a single dipper. By moving the wave generator at a constant speed, the Doppler phenomenon can be observed in the water table as illustrated in Figure 10. It will require some experimentation to determine the right speed to use for a given generator frequency.